



Model: SR-U200-3S

Description: SP3T, Reflective, PIN-Switch
Operating Frequency: 0.5 – 18 GHz
Insertion Loss: 2.4 dB Max
Isolation (Arm-to-Arm):

Table with 2 columns: 0.5 – 10 GHz, 10 – 18 GHz. Row 1: 60 dB Min, 50 dB Min.

VSWR ("ON" paths): 1.8:1 Max
Rise/Fall time (10% to 90% RF, 90% to 10% RF): 20 ns Max
On/Off time (50% TTL to 90% RF, 50%TTL to 10% RF): 60 ns Max
Operating Power: CW&AVG: +30dBm Max
Peak: 10W @ 1µS PW Max
Control Input Characteristics: Std. TTL / Unit-Load / Floating-High
Control Logic: 3-Controls, Logic "0" = RF Path "ON"
Power Supplies: +5(±0.25)V @ 90mA Max
-12(±0.5)V @ 60mA Max
Connectors (RF): SMA (f), Removable
Connectors (Supplies/Controls) Solder Pins
Impedance: 50 Ω Nominal
Quality: Best-Commercial-Grade

Environmental Ratings:

Temperature: {Operating: -55°C to +95°C} & {Storage: -60°C to +110°C}
Humidity: MIL-STD-202F, Method 103B, Cond. B (96 hours at 95% R.H.)
Shock: MIL-STD-202F, Method 213B, Cond. B (75G, 6mSec)
Vibration: MIL-STD-202F, Method 204D, Cond. B (.06" double amplitude, or 15G)
Altitude: MIL-STD-202F, Method 105C, Cond. B (50,000 Feet)
Temp. Shock: MIL-STD-202F, Method 107D, Cond. A (5 cycles)

Available Options:

(Units with listed options here may be subject to some specification tradeoffs from the standard, consult factory)

Supply Voltages

- A1 [+5(±0.25)V / -5(±0.25)V]*
A2 [+5(±0.25)V / -15(±0.5)V]
A3 [+12(±0.5)V / -12(±0.5)V]
A4 [+15(±0.5)V / -15(±0.5)V]

Control Function

- F1 [Inverse Logic, ("1" = Path "ON")]
F2 [2-Bit Binary Control] ; see below for "Outline Drawing" and "Function Table"

RF Connectors

- B1 [J1 – J3 Ports with SMA(M)]
B2 [All SMA (M)]
B3 [COM Port with SMA(M)]

Video Suppression Filter

- G1 [VF @ COM Port <> 0.25 dB additional Loss]
G2 [VF @ J1 – J3 Ports <> 0.25 dB additional Loss]
G3 [VF @ All Ports <> 0.5 dB additional Loss]

* Recommended for Low Power Consumption ; Additional switching delay & limited power rating (consult Factory)



Model: SR-U200-3S

Outline

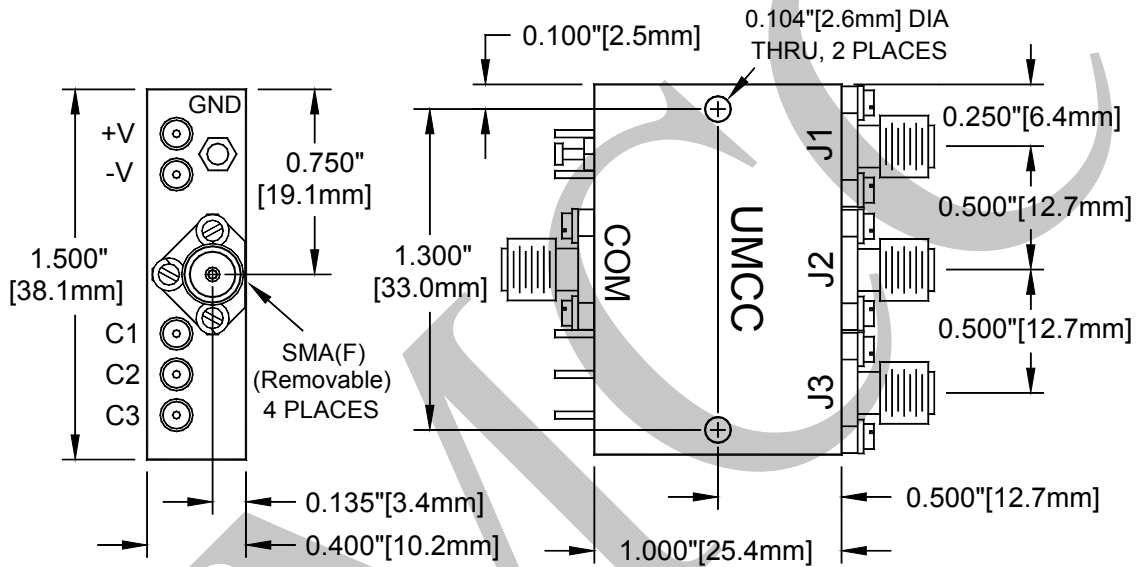

Weight	Tolerances
1.0 oz [28.3g]	±0.015" [±0.38mm]



Model: SR-U200-3S

Outline Drawing (SP3T with Option "F2")

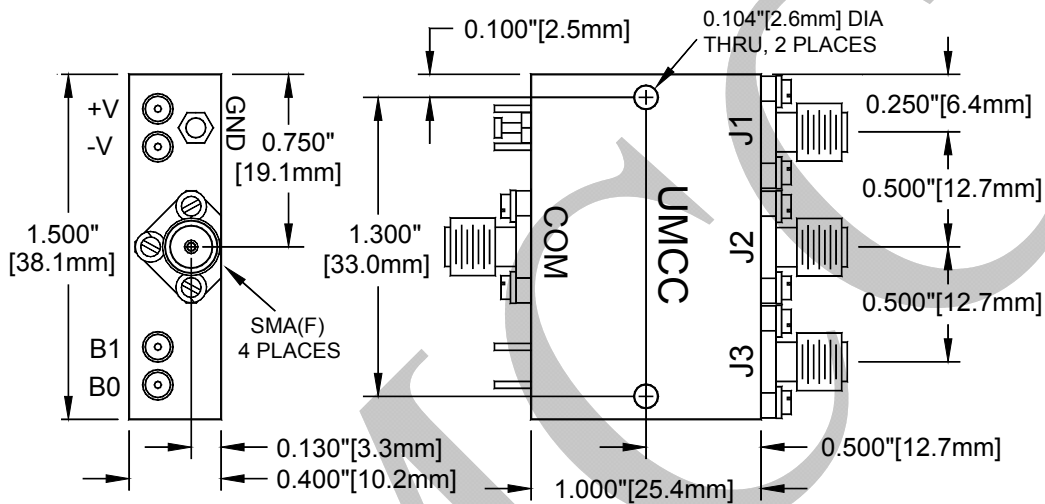

Weight	Tolerances
1.0 oz [28.3g]	±0.015" [±0.38mm]

Function Table for Option "F2" (2-Bit Binary Control)

INPUTS		RF PATH		
B1	B0	J1	J2	J3
0	0	ON	OFF	OFF
0	1	OFF	ON	OFF
1	0	OFF	OFF	ON
1	1	OFF	OFF	OFF