



Model: DC-0030-30N

Description:..... 30dB Directional Coupler
 Operating Frequency:..... 10 KHz - 30 MHz
 Coupling (reference to input):..... 30 ± 1 dB Nominal
 Coupling Flatness:..... ± 0.5 dB Max
 Insertion Loss (including coupled power):..... 1.3 dB Max
 Directivity: 19 dB Min
 VSWR: 1.35:1 Max
 Power Handling: 2W CW / Peak
 Connectors: N (f)
 Impedance: 50 Ohms Nominal
 Quality:..... Best-Commercial-Grade

Environmental Ratings:

Temperature:..... {Operating: -40°C to +85°C} & {Storage: -50°C to +100°C}
 Humidity: MIL-STD-202F, Method 103B, Cond. B (96 hours at 95% R.H.)
 Shock: MIL-STD-202F, Method 213B, Cond. B (75G, 6mSec)
 Vibration: MIL-STD-202F, Method 204D, Cond. B (.06" double amplitude, or 15G)
 Altitude: MIL-STD-202F, Method 105C, Cond. B (50,000 Feet)
 Temp. Shock: MIL-STD-202F, Method 107D, Cond. A (5 cycles)

Outline

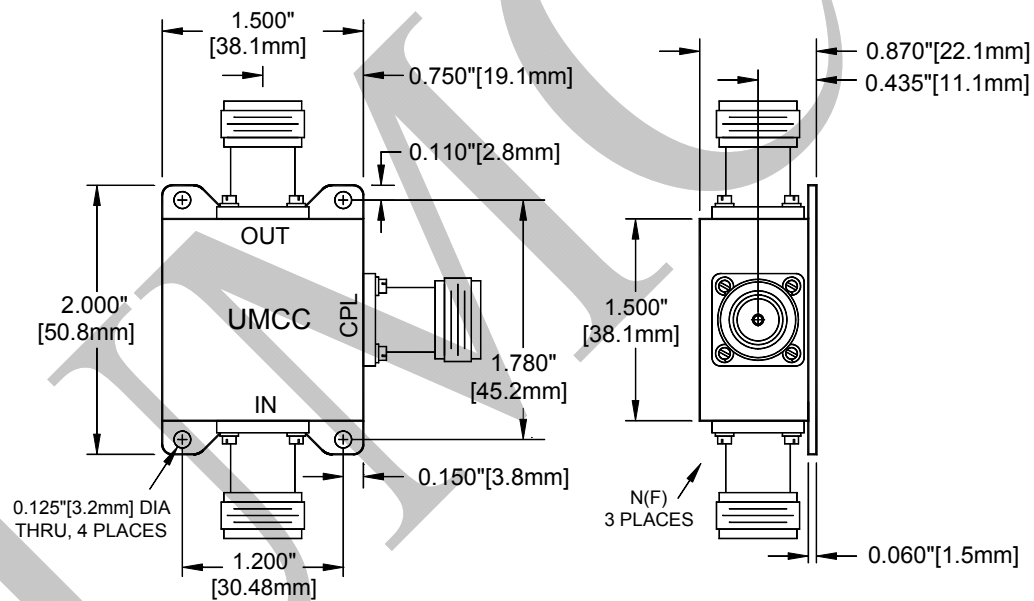

Weight	Tolerances
3.7 oz [105 g]	±0.015" [±0.38mm]