



Model: BC-D000-20S

Description:	20 dB Bi-Directional Coupler
Operating Frequency:	2 - 4 GHz
Coupling (reference to input):	20 ± 1 dB Nominal
Coupling Flatness:	± 0.6 dB Max
Insertion Loss (including coupled power):	0.5 dB Max
Directivity:	18 dB Min
VSWR:	Line 1.25:1 Max
	Couple 1.30:1 Max
Power Handling:	50 W Cw/Avg Max
Connectors:	SMA (f)
Impedance:	50 Ω Nominal
Quality:	Best-Commercial-Grade

Environmental Ratings:

Temperature:	{Operating: -40°C to +85°C} & {Storage: -50°C to +100°C}
Humidity:	MIL-STD-202F, Method 103B, Cond. B (96 hours at 95% R.H.)
Shock:	MIL-STD-202F, Method 213B, Cond. B (75G, 6mSec)
Vibration:	MIL-STD-202F, Method 204D, Cond. B (.06" double amplitude, or 15G)
Altitude:	MIL-STD-202F, Method 105C, Cond. B (50,000 Feet)
Temp. Shock:	MIL-STD-202F, Method 107D, Cond. A (5 cycles)

Outline
 ("A" = 3.700" [94.0mm])

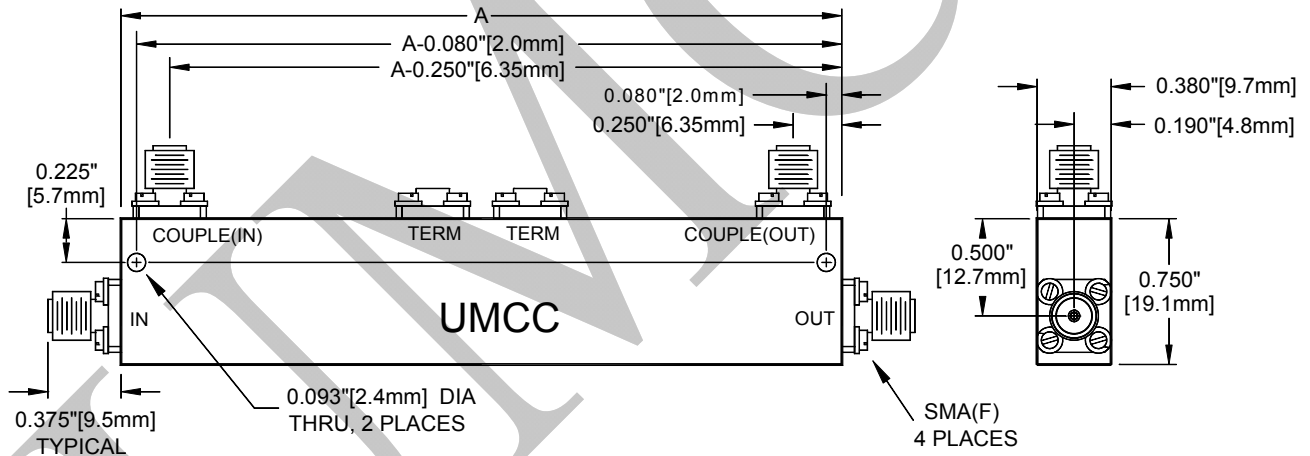

Weight
2.1 oz [59.5 g]